

PRODUCT CATALOGUE

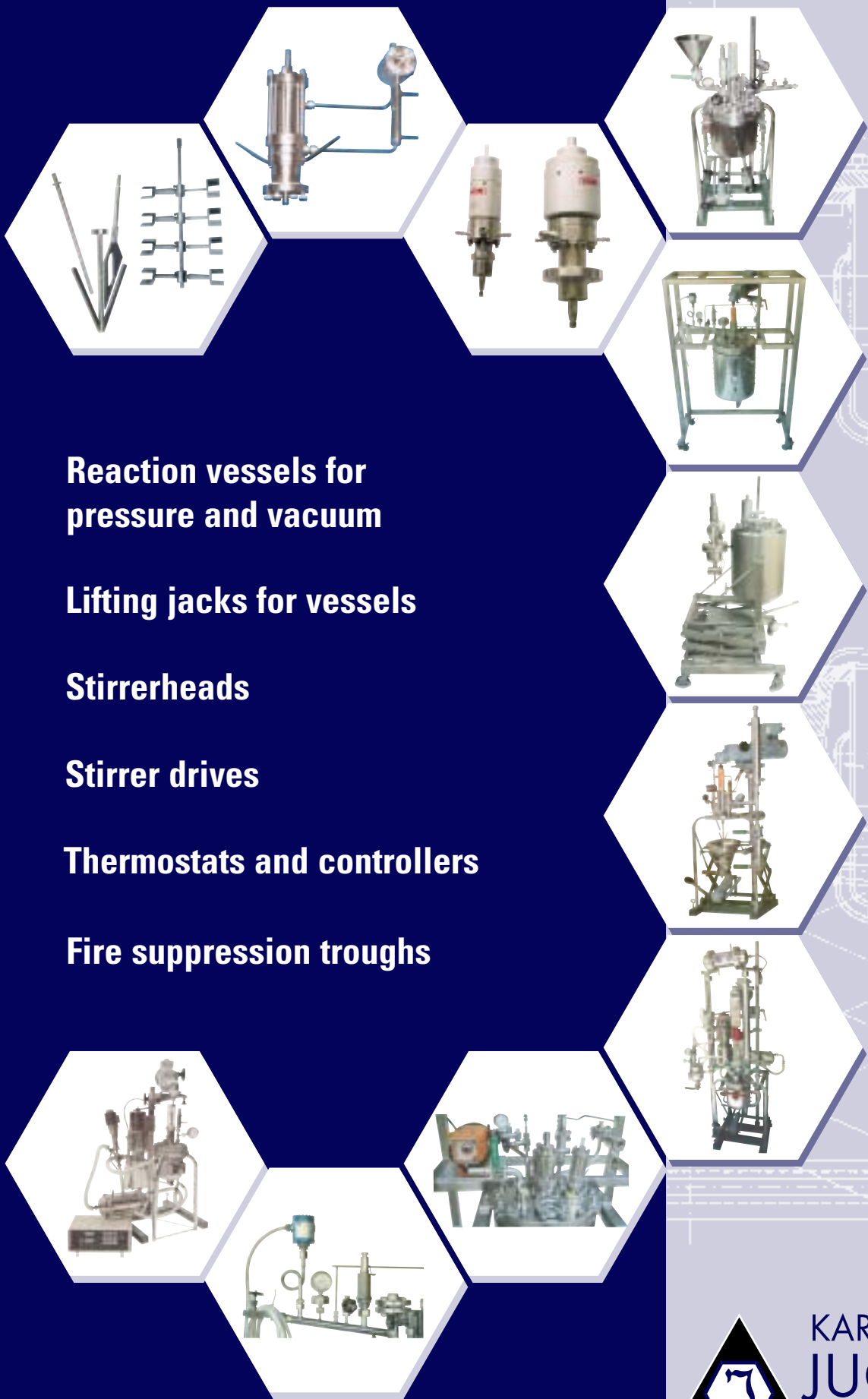

Reaction vessels for pressure and vacuum

Lifting jacks for vessels

Stirrerheads

Stirrer drives

Thermostats and controllers

Fire suppression troughs



**KARL KURT
JUCHHEIM**

Laborgeräte GmbH
seit 1927

Handwerkstraße
54470 Bernkastel-Kues
Tel. 0 65 31 / 96 44-0
Fax 0 65 31 / 96 44-15

**TÜV Rheinland/
Berlin-Brandenburg**



CERTIFICATE

Karl Kurt Juchheim
Laborgeräte GmbH
D-54462 Bernkastel-Kues

has fulfilled the quality requirements for welding activities
according to

DIN EN 729-3

The company provides qualified personnel
for the supervision of welding and non destructive testing.

The range of approvals - based on the valid welding procedure qualifications -
is given in the list of the welding procedure tests.

This certificate with No. 01 729-3 711-01 0059 is valid till

November 2004

Department for
Material and Manufacture

Senior engineer

Dipl.-Ing. F.J. Steinborn

Cologne, November 19, 2001

Zertifizierstellen der Unternehmensgruppe TÜV Rheinland/Berlin-Brandenburg

Köln – Berlin – Budapest – Brüssel – New York – Tokio



Skill and
Longstanding
Experience

Custom Design
and
Manufacture

Assured
Quality
and
Professional
Advice

Made in Germany

Research, development, production and the laboratory always need reaction vessels from 0.1 to 100 litres capacity, capable of working under vacuum or pressures up to 150 Bar, at temperatures ranging from -80°C to 400°C .

The single name JUCHHEIM brings together design and manufacture know-how, reasonable prices, and long-term reliability.

Its skills and years of experience in making reaction vessels and their accessories can bring your ideas to reality.

We specialise in the production of vessels of 0.5 to 128 L capacity working at

- Vacuum - 10E^{-3} mBar
- Pressure - 100 Bar
- Temperatures - -80°C to 400°C

The major components of a system comprise:

- **Reaction vessels and accessories**
Stirrerheads, stirrers, connections and drains
- **Auxiliary equipment**
Stirrer drive motors, lifting jacks, feeders, and condensers
- **Heating and cooling**
Recirculating thermostats, heat exchangers, valves and controllers.

All these and a standard range of reaction vessels from 1 to 50 litres are described in this catalogue.

The company is licensed by TÜV Rheinland to manufacture pressure vessels in various materials.

We are experienced in the manufacture of vessels complying with GMP (Good Manufacturing Practice) for use in the food and pharmaceutical industries.

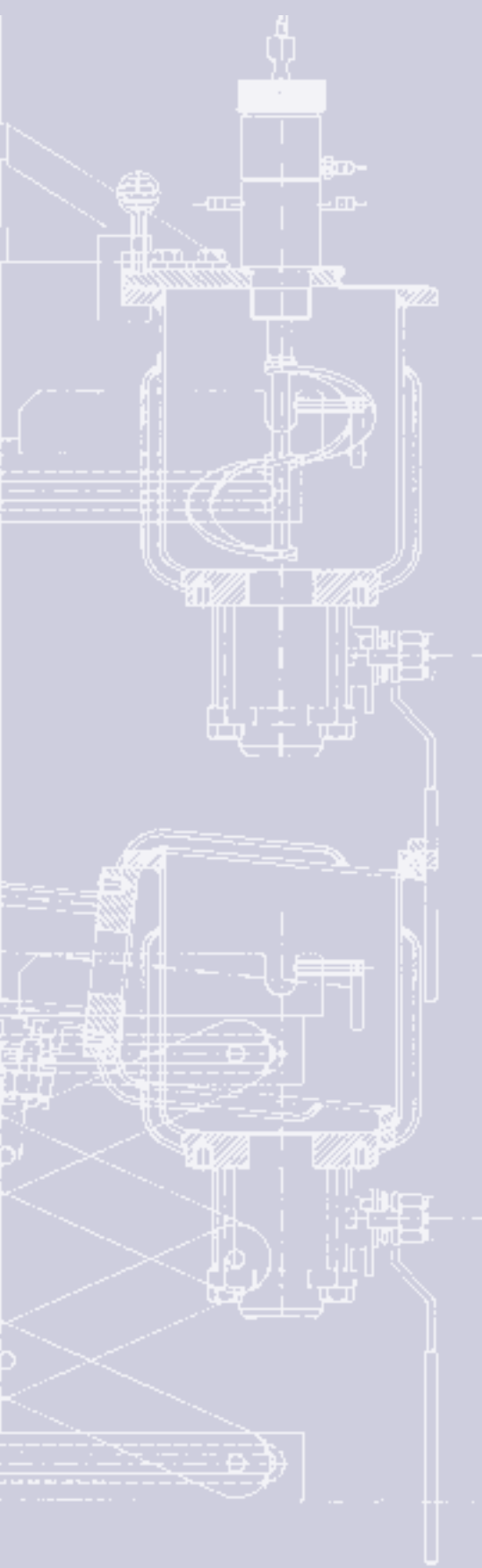

KARL KURT
JUCHHEIM

Laborgeräte GmbH
seit 1927

54470 Bernkastel-Kues

Deliveries

Post and parcels:

Handwerkstraße

Goods:

Hermann-Zillig-Straße

Postal address

Postfach 1229/1230

54462 Bernkastel-Kues

Telephone/Fax

Tel. 0 65 31 / 96 44-0

Fax 0 65 31 / 96 44-15

E-mail

info@juchheim-gmbh.de

info@karl-kurt-juchheim.com

info@juvo-germany.de

info@juvo-germany.com

World Wide Web

www.juchheim-gmbh.de

www.karl-kurt-juchheim.com

www.juvo-germany.de

www.juvo-germany.com

PRODUCT RANGE

Reaction vessels	4–27
Reaction vessels for vacuum, pressure and vacuum	
Special vessels	28–35
Reservoirs, pressure filter vessels, glass vessels, transporters, condensers	
Accessories	36–49
Sightglasses, drains, connections, pressure gauges, valves, excess pressure, valves, bursting disks, gaskets	
Lifting jacks, stirrer drives, torque measurement	50–55
Lifting jacks for vessels or vessel lids, stirrer drives, torque measurement and tachometers	
Stirrerheads for metal vessels	56–75
Stirrerheads with 'O' ring seals, mechanical seals, magnetically coupled stirrerheads	
Stirrer drive couplings and shields	76
Double universal drive couplings and their shields	
Stirrers	77–82
Anchor, helical, countercurrent, impeller, propeller, turbine stirrers, dispersion disks	
Conical joint stirrerheads and stirrers for glass flasks	83–86
Stirrerheads for vacuum and slight positive pressures, stirrers	
Thermostats and accessories	87–101
Thermostats from 2 - 9kW, heat exchangers from 0.16 m ² to 1 m ² Controllers, accessories	
Glass flask holders, fire suppression troughs	102–103
Glass flask holders Fire suppression troughs in various sizes	
General information	106–109
Materials, index	



Accessories for Stirrerheads and Reaction vessels

Item	Cat. no.
Double Universal Joints	
For stirrerheads 10210-10262.00, 10310.00 Female 6 x 6 mm square drive Chromium plated brass maximum torque 10 Nm	20440.00
Stainless steel Maximum torque 35 Nm	20440.11
Double Universal Joint	
For stirrerheads 10310-10312.00 Female 8 x 8 mm square drive Chromium plated brass Maximum torque 10 Nm	20441.00
Stainless steel Maximum torque 35 Nm	20441.11
Double Universal Joint	
Chromium plated brass Round 8 mm female, with locking screw Maximum torque 10 Nm	20442.00
Stainless steel Round \varnothing 17 mm female, with slot Maximum torque 35 Nm	20442.11
Round \varnothing 17 mm female, with slot for use with stirrerhead 10313.00	20442.17
As above, but with shear pin to limit torque	20442.16
Double Universal Joint	
Chromium plated brass Internal diameter 13 mm	20443.00
Stainless steel Internal diameter 16 mm	20443.11
Universal Joint Shields	
With thick Plexiglas walls and an aluminium fixing ring. for stirrerheads	
B29	20444.00
B45	20445.00
10310.00	20446.00
10312.00	20447.00
10309.00	20447.10
10311.00	20448.00
10313.00	20449.00

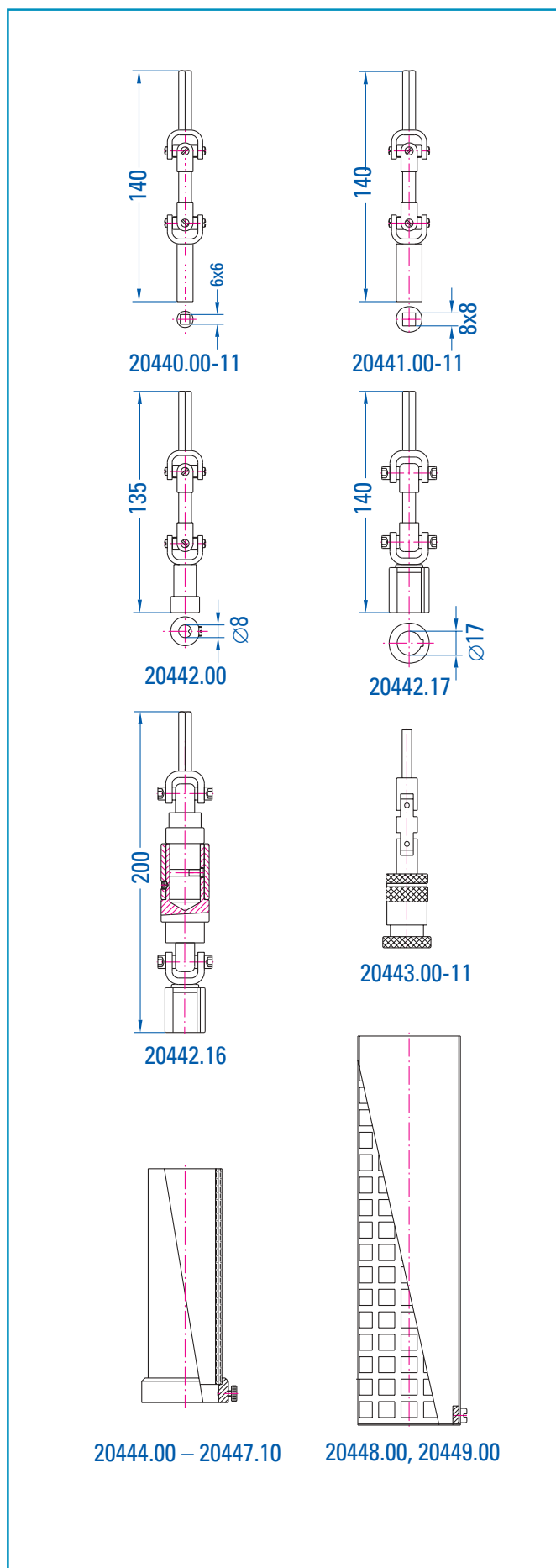



Materials:

Rust and acid resistant stainless steel - 316
German designation: 1.4571

➔ See *chemical resistance tables page 36*

Unsuitable for applications involving the presence of halide ions. Standard material for vessels and accessories. Suitable for most applications. Lowest cost material.

The company is licensed and supervised by TÜV Rheinland to fabricate pressure vessels in this material.

Nickel based alloy - Hastelloy C4®
German designation: 24610

Highly resistant material for vessels and accessories. Highly suited for applications involving acids, and other applications for which stainless steel is unsuited.

Stocks are held of materials and spare parts made from this material.

The company is licensed and supervised by TÜV Rheinland to fabricate pressure vessels in this material.

Nickel based alloy - Alloy 59
A nickel-chromium-molybdenum based alloy

The company is licensed and supervised by TÜV Rheinland to fabricate pressure vessels in this material.

Additional information about chemical resistance and composition of the alloys mentioned above and others is available on the World Wide Web.

A good source of information is:
<http://www.corrosionsource.com>

Other materials are possible. Contact us for details.

GMP (Good Manufacturing Practice) Standard for pharmaceutical applications.

Vessels and accessories can be manufactured to comply with the GMP code.

The standard requires that the vessel and its accessories can be cleaned according to a written procedure, and the results must accord with a written procedure.

To achieve this certain modifications are made to the design and to the fabrication process.

Design modifications:

Elimination, as far as possible, of all dead spaces in gaskets, seals, connections, valves and monitoring equipment.

Specification of sightglasses, valves without dead space, and membrane pressure gauges.

Elimination, as far as possible, of exterior crevices, e.g. any thermal insulation is sheathed and permanently welded onto the vessel.

Manufacturing modifications:

Surface roughness lower than 0.8 µm. Reaction vessels can be made to a roughness down to 0.3 µm. Exterior roughness 3 µm maximum. Surfaces to be inspected at various points.

Vessel marking to be done chemically instead of by nameplates. All bearings and channels in lifting gear and stands to be sealed.

Approved materials to be used. In food or pharmaceutical applications gasket and sealing materials must be FDA (Food and Drug Administration) approved.

A list of all components with all relevant documentation.



- A**
- Adaptors
 - conical joint, no cap 45
 - conical joint, with cap 45
 - spherical joint 45
 - vessel lid ports 45, 46
 - welding - reaction vessels 42
 - welding - thermostats 92
 - Addresses
 - e-mail 2
 - fax 2
 - goods inward 2
 - postal 2
 - telephone 2
 - web 2
- B**
- Bursting disks 42
- C**
- Certification 36
 - Chemical resistance mechanical seals 62
 - Clamps
 - pressure vessels 26
 - vacuum vessels 49
 - Condensers
 - Liebig 28, 35
 - reflux 28, 35
 - tube and shell 28, 35
 - Conditions of sale 109
 - Connectors
 - glass-metal 94, 98
 - glass-metal, DN10/DN15 94
 - thermostat hoses 92
- D**
- Double universal joints 76
 - Drains
 - plugs 38
 - valves 38
 - welded ball valves 38
- F**
- Flame suppression troughs 103
- G**
- Gas inlet tube 45
 - Gaskets 47, 48
 - bursting disk 42
 - conical joint adaptor caps 48
 - general purpose 47
 - materials 47
 - port adaptors 47
 - reaction vessel 48
 - sightglasses 43, 49
 - tube and shell condenser 47
- H**
- Heat exchangers 95
 - Heat transfer fluid 87, 91
 - Hose connectors 94
- I**
- Insulation
 - reaction vessel 4
 - thermostat hoses 91, 98, 99
- L**
- Laboratory equipment 112
 - Lifting jacks 50, 51
- M**
- Materials 8, 36, 106
 - Marlotherm SH 87, 91
- P**
- Pressure gauges
 - analogue 11, 40
 - electronic 40
 - membrane 40
- R**
- Reaction vessels
 - adaptors 45
 - conical 27
 - equipment 36 onwards
 - glass 28
 - glass, accessories 33
 - heating 87-101
 - pressure 8-27
 - raising and lowering 4, 8, 60
 - special pattern 8, 21, 39, 106
 - stainless steel 4
 - standard pattern 9-27
 - vacuum 4, 27
 - valves, see "valves"
 - Receiver vessels 78, 85
 - Reservoir vessels 28, 29
- S**
- Safety valves 11, 42
 - Shear pin coupling 76
 - Sightglass illuminator 43
 - Spares
 - magnetic stirrerheads 69, 71, 73, 75
 - mechanically sealed
 - stirrerheads 63, 65, 67
 - mechanical seals 62-67
 - pressure stirrerheads 59, 61
 - reaction vessels 36-49
 - sightglasses 43
 - thermostat, 2 & 4 kW 96
 - thermostats 96, 97
 - vessel gaskets 49
 - vessel lid bolts 49
 - Stands, stirrer drive 53
 - Stirrer drives 52, 53
 - Stirrerheads
 - conical joint 4, 83, 84
 - for glass Reaction vessels 83
 - magnetic 68, 70, 72, 74, 84
 - mechanically sealed 62, 64, 66
 - 'O' ring sealed 57, 58, 80
 - pressure 51 - 55
 - Stirrers
 - aeration 82
 - anchor 78, 86
 - anchor, sloped 82
 - countercurrent 81
 - dimensions 77
 - dispersion disks 79
 - for Juvo stirrerheads 85
 - helical 79
 - Hoesch 85
 - leaf 85
 - propeller 80, 86
 - shafts 78
 - turbine 81
 - wing 85
 - Stirrer shafts 78, 85
 - Stirrer speed 54, 55
 - Stirrer torque
 - display 54, 55
 - measurement 54, 55
 - Surface finish 4, 8, 106



T		V	
Tachometer	54, 55	Valves	
Thermometers		90 \varnothing	41
mercury in glass	92	excess pressure	42
Thermometers, Pt100		plug	41
for thermometer pockets	44	sampling	39
for thermostats	94	straight	41
vessel base	39	Vessels, see "Reaction vessels"	
Thermostat			
3 way valve	93		
Thermostat			
accessories - 9 kW	101		
accessories - 2 kW, 4 kW	90, 92		
connection schematics	88, 89, 99		
connection schemes	98, 99		
cooling water valve	93		
expansion chamber	87, 89, 90		
heat exchanger holder	94		
high temp. on-off valve	95		
high temp. proportioning valve	95		
hoses	91		
mounting	94		
thermometer holder	92		
Thermostat adaptors			
threaded	92		
welding	92		
Thermostat controllers	88, 90, 101		
Thermostats	87, 88, 89, 90		
2 kW	90		
4 kW	90		
9 kW	100		
Tools			
Ring key	49		
C-spanner	49		
Transporter vessels	28, 34		
Tripods	9 onwards		



Conditions of sale and payment

- 1 Only our sale and payment conditions apply. Purchase conditions applied by customers are explicitly excluded. We are not bound by such conditions even if they are not excluded at the finalisation of any particular contract of sale.
- 2 All prices are ex-works, excluding packing. Quotations are valid for 6 months only. We reserve the right to raise prices if manufacturing costs increase between the date of ordering and the date of delivery.
- 3 Minimum order value € 25.00 net excluding VAT. For deliveries under the minimum order value an administration charge of € 5.00 will be added in addition to packing and dispatch costs.
- 4 Packing is charged at cost and is not returnable. Railway delivery within the Federal Republic of Germany is generally effected through rented Bahncolicos, which must be emptied and returned immediately after receipt. Return freight for Bahncolicos is free.
- 5 Quotations must not be disclosed to third parties and competing firms.
- 6 If items are specially manufactured, we reserve a right to a delivery margin of + or - 10%.
- 7 As far as our facilities allow us to do so, we will manufacture special products in a proper and timely manner on the basis of samples, drawings or information provided by the customer. No returns or exchanges of specially manufactured goods will be allowed, but any shortages will be made up.
- 8 Delivery dates are not binding. Operational difficulties outside our control or forces majeure allow us to postpone previously agreed delivery dates, or to cancel the contract. Penalty clauses for late delivery are not accepted.
- 9 Our order acknowledgements serve as the confirmation of an order. Small orders and orders met ex-stock will not be acknowledged.
- 10 Delivery and transport are at the buyer's cost and risk. In the absence of specific instructions, packaging and means of delivery are chosen on basis of greatest suitability, rather than minimum cost.
- 11 Shortages must be notified in writing 8 days after delivery at the latest. Hidden faults must be disclosed immediately on discovery, but within 1 month from the date of invoice at the latest. When a claim is acknowledged the purchaser is entitled to reworking or a make-up delivery. Further claims, especially those engendered by reworking or make-up deliveries will not be entertained.
- 12 Commercial rights: we are unable to check in detail if the production or delivery of goods according to a drawing or sample infringes the rights of third parties. The risk is borne by the purchaser. If required by us, the purchaser must indemnify us against claims for infringement of these rights. All costs involved are to be borne by the customer.
- 13 Except in the case of delivery errors, returns or exchanges of specially manufactured goods is not allowed.
- 14 No responsibility for damage consequent on the use of our products will be accepted.
- 15 We reserve the right to make technical modifications to our products.
- 16 Payment: within 8 days with 2% discount, within 30 days net. For foreign payments under € 250.00, all costs of payment must be incurred by the purchaser, otherwise they will be subsequently invoiced. Transfers through the Post system are free of charge. Cheques and transfers are only accepted subject to clearance. Payment is not considered to be effected until such instruments have been cleared. We recognise discounts only when payments are received within the time allowed. The time of payment is taken to be the date of transfer from the settling institution, or the postmark in the case of settlement by cheque.
- 17 Delays in payment entitles us to block any further deliveries. Additionally, we are entitled to demand immediate settlement of outstanding and any further sums due. Interest will be charged at 2% over local bank rate. Non-compliance with payment conditions entitles the seller to demand payment in advance for outstanding deliveries or for guarantors, and after suitable notice to withdraw from the contract or to demand indemnity against claims for non-fulfilment of the contract.
- 18 Ownership: all goods supplied remain our property until payment of all invoices, including those stemming from other deliveries and actions. Working and processing of goods are done according to §950 of the Federal German Legal code, with the exception of ownership claims. The goods produced are our collateral. If required by us, the buyer must inform the end user of the goods of this condition. In the case of loss of ownership through alienation or further working, the buyer relinquishes in advance all the demands stemming from such alienation or other legal grounds.
- 19 In the case of arrears of payment or significant degradation of the financial position of the purchaser, with the opening of agreement with creditors or bankruptcy, the seller is entitled to demand the return of all goods subject to our ownership and to rescind any outstanding contracts to supply. The buyer must inform us immediately of any pledge to or interest of third parties.
The competent court for all questions, including payments, is Bernkastel-Kues. German law applies in all cases.

Karl Kurt Juchheim Laborgeräte GmbH

Note: We reserve the right to make modifications on grounds of technical improvements.

Although all reasonable care has been taken to ensure accuracy, we can take no responsibility for any errors.



**Transportable turnkey plant,
explosion-proof, in stainless
steel framework with:**

- Main reactor with 16 Nm magnetic stirrerhead and continuously variable stirrer drive
 - Stirred reservoir, mechanically sealed stirrerhead and a rectangular lateral sightglass
 - Heated reflux condenser and tube-and-shell condenser with receiving vessel
- Lifting jack and vacuum pump

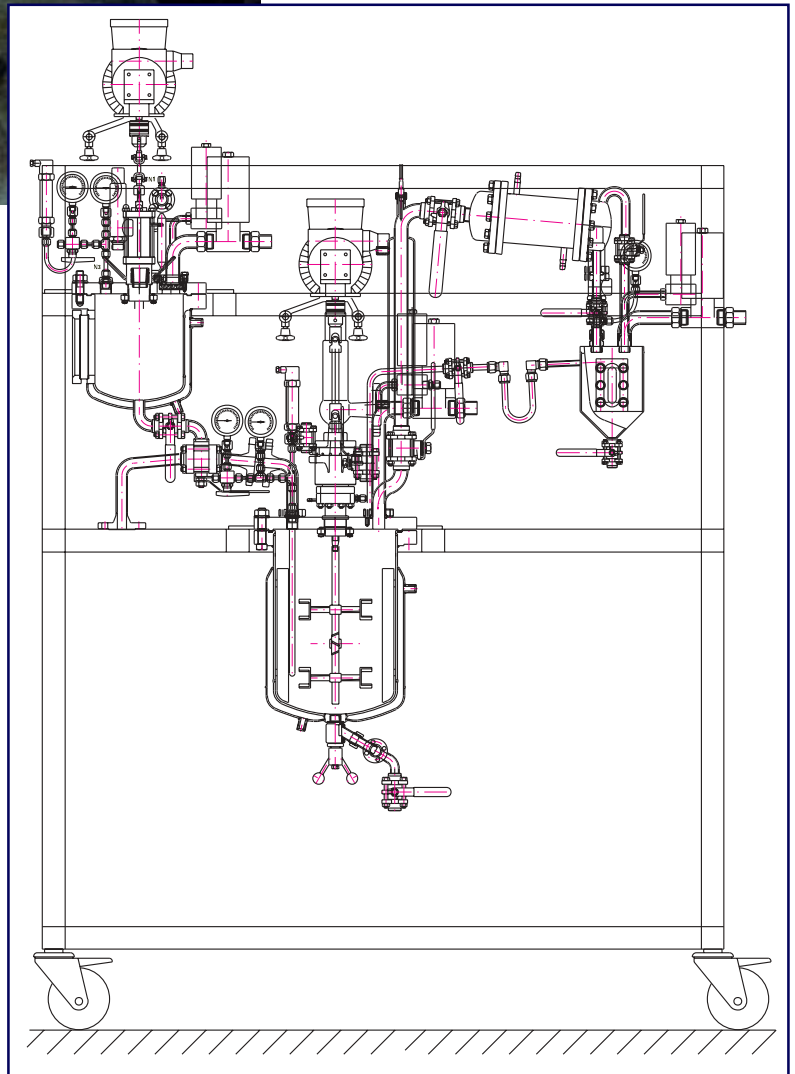

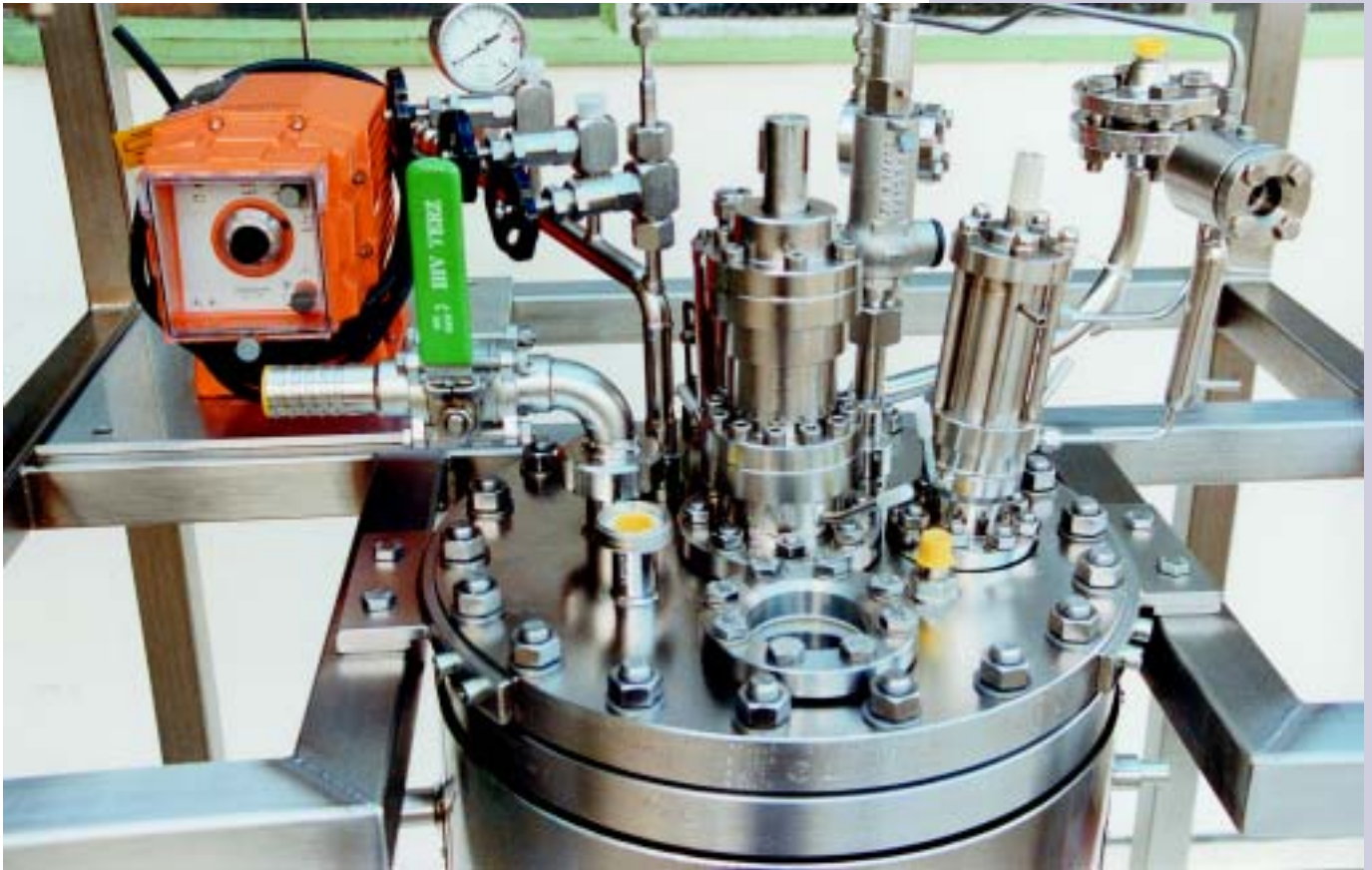

Reaction vessel, 50 litres, in stainless steel framework

- With various manifolds and connections
- Mechanically sealed stirrerhead with 25 mm shaft and a sloping stirrerhead to one side



KARL KURT JUCHHEIM

Laborgerätebau GmbH



Apparatebau
Spezialanfertigungen
für
Laborgeräte



Laborbrenner
nach
Bunsen, Teclu, Heinze
Mikro- u. Sicherheits-
brenner
Gebläsebrenner



Stativklammern
aus
Edelstahl (18/8)
Stahl
Temperguß



Verstellbare Druckgas-
Flaschenhalterung
Brandschutzwannen
Spinnmilben-
Bürstenmaschinen
Reagenzglasgestelle



Karl Kurt Juchheim
Laborgeräte GmbH
Postfach 1229 – 1230
Handwerkstraße
54462 Bernkastel-Kues
Tel.: (0 65 31) 96 44-0
Fax: (0 65 31) 30 17

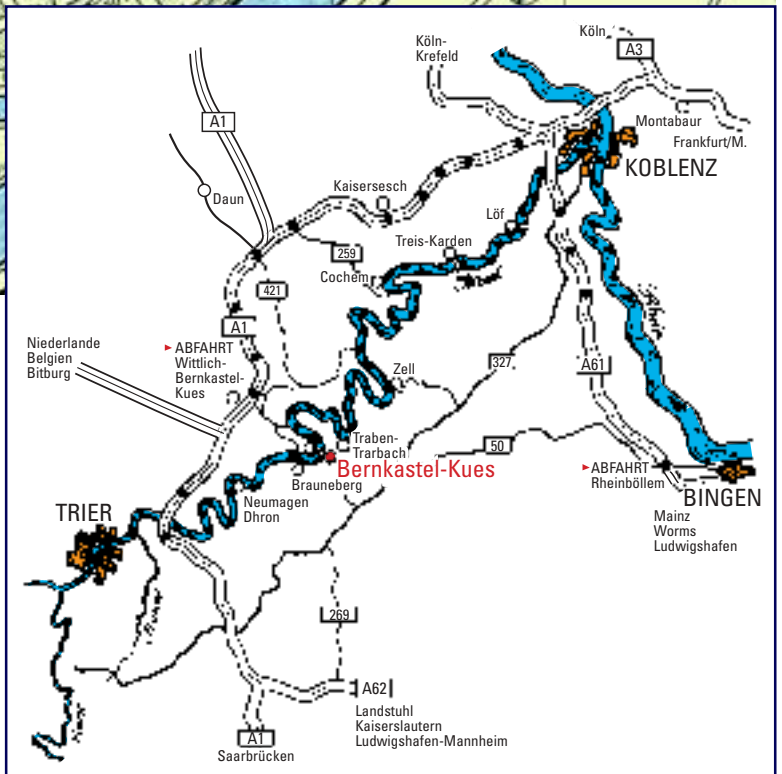
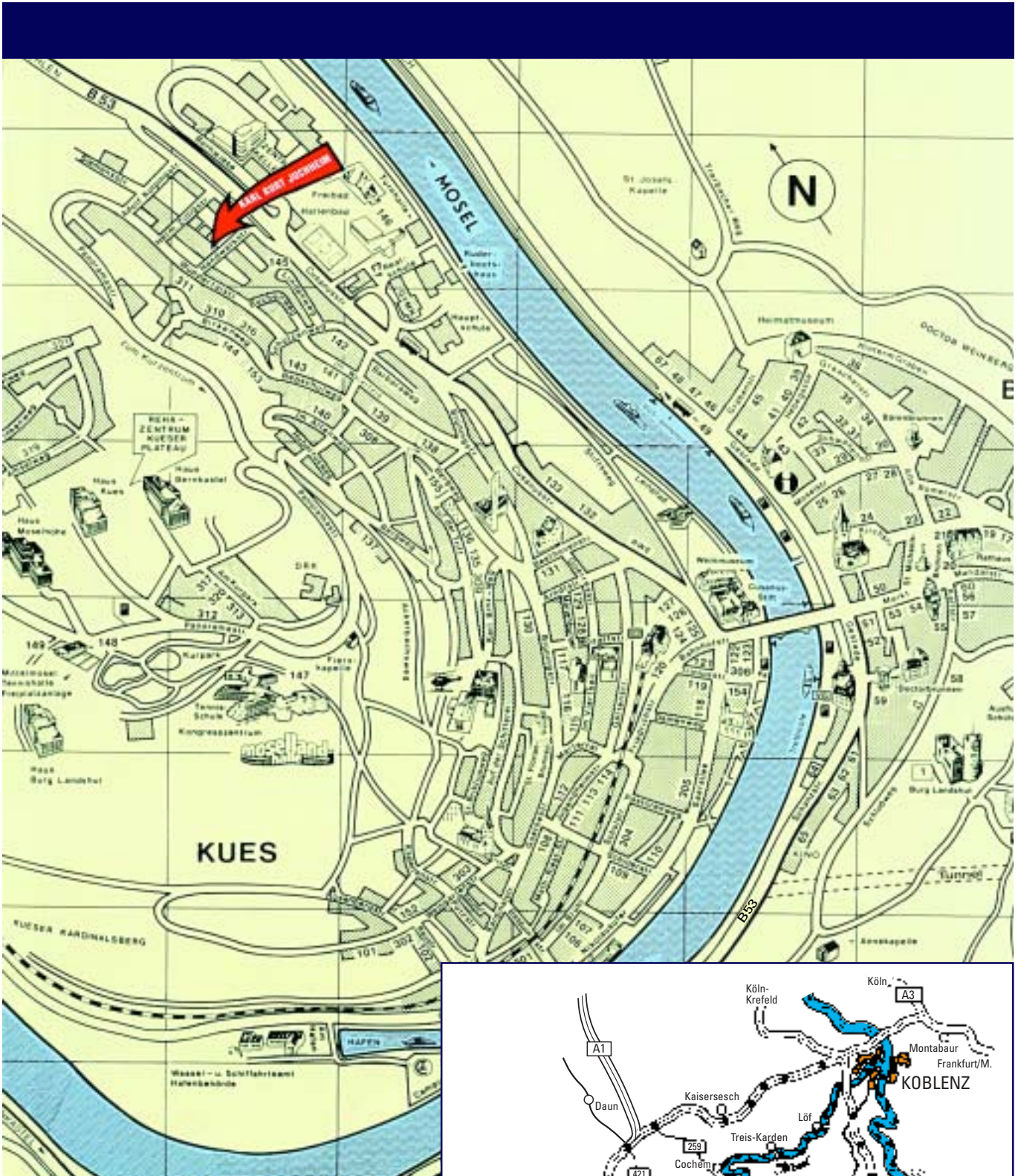

**KARL KURT
JUCHHEIM**

Laborgeräte GmbH
seit 1927

Handwerkstraße · 54470 Bernkastel-Kues
Tel. 0 65 31 / 96 44-0 · Fax 0 65 31 / 96 44-15
E-Mail: info@juchheim-gmbh.de
Internet: www.juchheim-gmbh.de

